

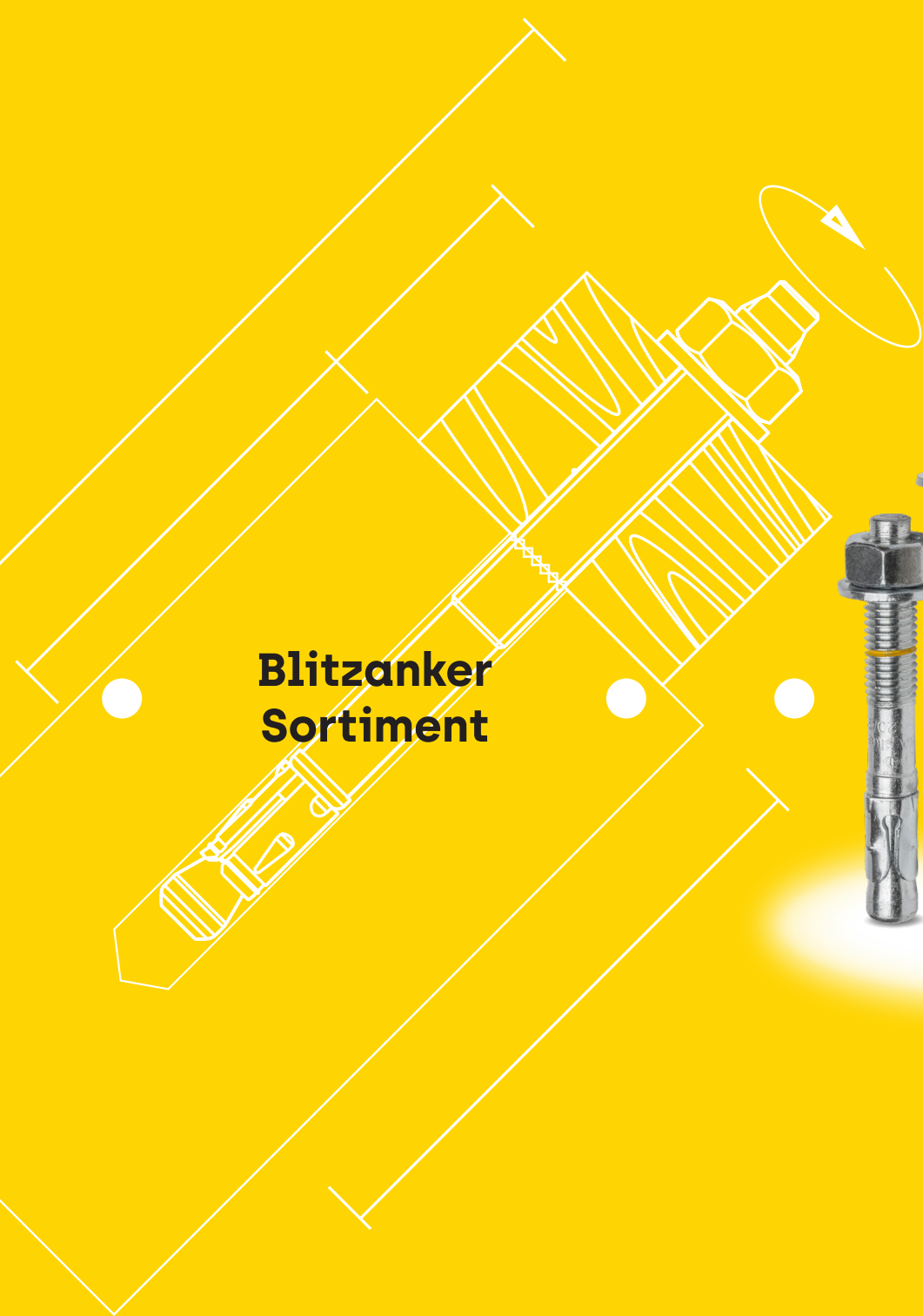

# CELO

**Blitzanker  
Sortiment**



**Für jede Anwendung  
der richtige  
Blitzanker!**



<b>BAZ plus</b>	<b>4</b>
<b>BAZ</b>	<b>7</b>
<b>BA plus</b>	<b>11</b>
<b>BA A4</b>	<b>14</b>



Blitzanker	BAZ plus		BAZ				BA plus		BA A4
<b>Beschichtung / Material</b>	galvanisch verzinkt	nicht-rostender Stahl A4	galvanisch verzinkt	feuer- verzinkt	nicht-rostender Stahl A4	hoch- korrosions- beständig HCR	galvanisch verzinkt	galvanisch verzinkt	nicht-rostender Stahl A4
<b>Sortiment</b>	M8 - M16		M8 - M16			M8 - M10	M6 - M20	M10 - M16	M8 - M16
	Option 1		Option 1				Option 7		Option 7
 siehe Bewertung	✓		✓				✗		✗
	✓ C1, C2 C2: M10-M16		✓ C1 M8-M16				✗		✗
 M8 - M16	✓		✓				✗		✗
	✗	✓	✗	✗	✓	✓	✗	✓	
<b>Für Außenanwendungen geeignet</b>	✗	✓	✗	ohne ETA	✓	✓	✗	✓	
<b>Setztiefen- markierung</b>	✓		✗				✓		✗
<b>Leistung</b>									
<b>Prägung auf dem Kopf</b>	✓		✗				✗		✗
<b>Zwei Setztiefen</b>	✓ M10 & M12		✗				✗		✗
<b>Mit großer Scheibe für den Holzbau</b>	✗		✗				✗	✓	✗
<b>Als Blister oder Einzelpreis erhältlich</b>	✗	✓	✓	✗	✓	✗	✓	✓	✗
<b>Seite</b>	4		7				11		14

# Blitzanker BAZ plus



## Vorteile



BAZ plus, galv. verz.



BAZ plus A4, nichtrostender Stahl A4



## Geeignete Baustoffe

### Sehr gut geeignet

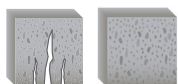

- Beton gerissen
- Beton ungerissen



## Zulassungen und Zertifikate



Europäisch Technische Bewertung  
Option 1 für gerissenen Beton



siehe Bewertung



M8 - M16



## Montage

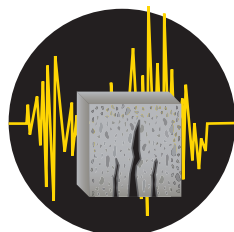
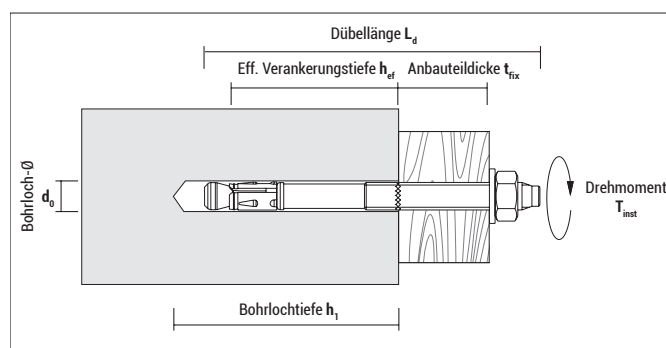
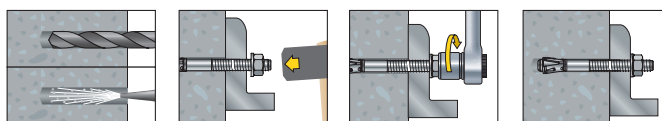

**Herausragende Leistung**  
in gerissenen Beton  
und unter seismischen  
Einwirkungen [C1 und C2]

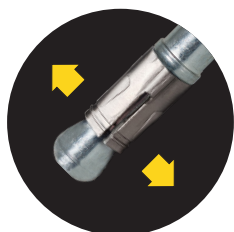

**Geringste Rand- und  
Achsabstände**  
perfekt für schwierige  
Einbausituationen

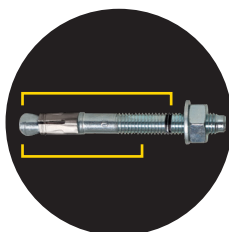

**Zwei Setztiefen  
bei M10 und M12**  
für flexiblen  
Einsatzbereich

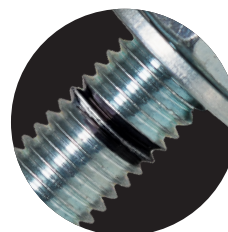



**Setztiefenmarkierung**  
als Montagehilfe



**Längenmarkierung**  
auf dem Kopf des  
Blitzankers





## BAZ plus, galv. verz.

Typ	Art.-Nr.	d <sub>0</sub> [mm]	h <sub>1</sub> ≥ [mm]	h <sub>er</sub> ≥ [mm]	L <sub>d</sub> [mm]	t <sub>fix</sub> ≤ [mm]	Gewinde		 [Stück]	 [Stück]
8-75/10	9875BAZP	8	60	48	75	10	M8	●	50	250
8-95/30	9895BAZP	8	60	48	95	30	M8	●	50	250
8-115/50	98115BAZP	8	60	48	115	50	M8	●	40	200
8-150/85	98150BAZP	8	60	48	150	85	M8	●	40	200
10-72/10	91072BAZP	10	55	40	72	10	M10	●	40	200
10-92/10	91092BAZP	10	55 / 75	40 / 60	92	30 / 10	M10	●	40	200
10-102/20	910102BAZP	10	55 / 75	40 / 60	102	40 / 20	M10	●	25	125
10-112/30	910112BAZP	10	55 / 75	40 / 60	112	50 / 30	M10	●	25	125
10-132/50	910132BAZP	10	55 / 75	40 / 60	132	70 / 50	M10	●	25	125
10-162/80	910162BAZP	10	55 / 75	40 / 60	162	100 / 80	M10	●	25	125
12-88/10	91288BAZP	12	70	50	88	10	M12	●	20	100
12-103/5	912103BAZP	12	70 / 90	50 / 70	103	25 / 5	M12	●	20	100
12-118/20	912118BAZP	12	70 / 90	50 / 70	118	40 / 20	M12	●	20	100
12-128/30	912128BAZP	12	70 / 90	50 / 70	128	50 / 30	M12	●	20	100
12-148/50	912148BAZP	12	70 / 90	50 / 70	148	70 / 50	M12	●	20	100
12-163/65	912163BAZP	12	70 / 90	50 / 70	163	85 / 65	M12	●	20	100
12-178/80	912178BAZP	12	70 / 90	50 / 70	178	100 / 80	M12	●	20	100
16-123/5	916123BAZP	16	110	85	123	5	M16	●	10	50
16-138/20	916138BAZP	16	110	85	138	20	M16	●	10	50
16-168/50	916168BAZP	16	110	85	168	50	M16	●	10	50
16-178/60	916178BAZP	16	110	85	178	60	M16	●	10	50



## BAZ plus A4, nichtrostender Stahl A4



Typ	Art.-Nr.	d <sub>0</sub> [mm]	h <sub>1</sub> ≥ [mm]	h <sub>er</sub> ≥ [mm]	L <sub>d</sub> [mm]	t <sub>fix</sub> ≤ [mm]	Gewinde		 [Stück]	 [Stück]
8-75/10 A4	9X875BAZP	8	60	48	75	10	M8	●	50	250
8-95/30 A4	9X895BAZP	8	60	48	95	30	M8	●	50	250
8-115/50 A4	9X8115BAZP	8	60	48	115	50	M8	●	40	200
8-150/85 A4	9X8150BAZP	8	60	48	150	85	M8	●	40	200
10-72/10 A4	9X1072BAZP	10	55	40	72	10	M10	●	40	200
10-92/10 A4	9X1092BAZP	10	55 / 75	40 / 60	92	30 / 10	M10	●	40	200
10-102/20 A4	9X10102BAZP	10	55 / 75	40 / 60	102	40 / 20	M10	●	25	125
10-112/30 A4	9X10112BAZP	10	55 / 75	40 / 60	112	50 / 30	M10	●	25	125
10-132/50 A4	9X10132BAZP	10	55 / 75	40 / 60	132	70 / 50	M10	●	25	125
10-162/80 A4	9X10162BAZP	10	55 / 75	40 / 60	162	100 / 80	M10	●	25	125
12-88/10 A4	9X1288BAZP	12	70	50	88	10	M12	●	20	100
12-103/5 A4	9X12103BAZP	12	70 / 90	50 / 70	103	25 / 5	M12	●	20	100
12-118/20 A4	9X12118BAZP	12	70 / 90	50 / 70	118	40 / 20	M12	●	20	100
12-128/30 A4	9X12128BAZP	12	70 / 90	50 / 70	128	50 / 30	M12	●	20	100
12-148/50 A4	9X12148BAZP	12	70 / 90	50 / 70	148	70 / 50	M12	●	20	100
12-163/65 A4	9X12163BAZP	12	70 / 90	50 / 70	163	85 / 65	M12	●	20	100
12-178/80 A4	9X12178BAZP	12	70 / 90	50 / 70	178	100 / 80	M12	●	20	100
16-123/5 A4	9X16123BAZP	16	110	85	123	5	M16	●	10	50
16-138/20 A4	9X16138BAZP	16	110	85	138	20	M16	●	10	50
16-168/50 A4	9X16168BAZP	16	110	85	168	50	M16	●	10	50
16-178/60 A4	9X16178BAZP	16	110	85	178	60	M16	●	10	50

### Montagedaten

BAZ plus Größe BAZ plus Typ		M8		M10		M12		M16	
		BAZ plus verz.	BAZ plus A4	BAZ plus verz.	BAZ plus A4	BAZ plus verz.	BAZ plus A4	BAZ plus verz.	BAZ plus A4
Drehmoment	$T_{inst}$ [Nm]	15	20	30	45	60		110	
Schlüsselweite	SW [mm]	13		17		19		24	
Durchgangsloch im anzuschließenden Anbauteil	$d_r$ [mm]	9		12		14		18	
Unterlegscheibe Außen-Ø x Dicke	[mm]	17 x 1,6		21 x 2,0		24 x 2,5		30 x 3,0	

### Achs- und Randabstände

BAZ plus Größe		M8	M10	M12	M16		
Effektive Verankerungstiefe	$h_{ef}$ [mm]	48	40	60	50	70	85
Minimaler Randabstand	$C_{min}$ [mm]	40	50	50	60	55	65
	für $S \geq$ [mm]	55	190	100	215	110	150
Minimaler Achsabstand	$S_{min}$ [mm]	35	50	40	55	60	65
	für $C \geq$ [mm]	50	95	60	110	70	95
Charakteristischer Randabstand	$C_{cr}$ [mm]	72	60	90	75	105	127
Charakteristischer Achsabstand	$S_{cr}$ [mm]	144	120	180	150	210	254
Mindestbauteildicke	$h_{min}$ [mm]	100	100	120	100	140	170
Reduzierte Mindestbauteildicke <sup>1)</sup>	$h_{min-red}$ [mm]	80	-	100	-	-	-

Bei Unterschreitung des char. Rand-/Achsabstandes ( $C_{cr}$  bzw.  $S_{cr}$ ) muss die Tragfähigkeit abgemindert werden.  $h_{min}$ ,  $S_{min}$  und  $C_{min}$  dürfen nicht unterschritten werden.

<sup>1)</sup> Reduzierte Mindestbauteildicke nur in ungerissemem Beton.

### Zulässige Tragfähigkeiten

BAZ plus Größe		M8	M10	M12	M16		
Effektive Verankerungstiefe	$h_{ef}$ [mm]	48	40	60	50	70	85
<b>Zulässige zentrische Zuglast<sup>1), 2)</sup> eines Einzeldübels ohne Randeinfluss in gerissemem Beton C20/25<sup>3)</sup></b>							
BAZ plus galv. verz.	$N_{zul}$ [kN]	4,0	4,1	5,7	5,8	7,6	11,4
BAZ plus nichtrostender Stahl A4	$N_{zul}$ [kN]	4,0	4,1	5,7	5,8	7,6	11,4
<b>Zulässige zentrische Zuglast<sup>1), 2)</sup> eines Einzeldübels ohne Randeinfluss in ungerissemem Beton C20/25<sup>3)</sup></b>							
BAZ plus galv. verz.	$N_{zul}$ [kN]	5,2	5,7	9,0	8,3	11,9	17,1
BAZ plus nichtrostender Stahl A4	$N_{zul}$ [kN]	5,2	5,7	9,0	8,3	11,9	17,1
<b>Zulässige Querlast<sup>1), 2)</sup> eines Einzeldübels ohne Randeinfluss in gerissemem Beton C20/25<sup>3)</sup></b>							
BAZ plus galv. verz.	$V_{zul}$ [kN]	7,2	11,7	11,7	17,1	17,1	30,9
BAZ plus nichtrostender Stahl A4	$V_{zul}$ [kN]	9,0	11,7	11,7	17,2	19,7	36,4
<b>Zulässige Querlast<sup>1), 2)</sup> eines Einzeldübels ohne Randeinfluss in ungerissemem Beton C20/25<sup>3)</sup></b>							
BAZ plus galv. verz.	$V_{zul}$ [kN]	7,2	11,7	11,7	17,1	17,1	30,9
BAZ plus nichtrostender Stahl A4	$V_{zul}$ [kN]	9,0	11,7	11,7	19,7	19,7	39,2
<b>Zulässiges Biegemoment<sup>1), 2)</sup></b>							
BAZ plus galv. verz.	$M_{zul}$ [Nm]	15,0	29,1	51,4	125,6		
BAZ plus nichtrostender Stahl A4	$M_{zul}$ [Nm]	14,3	29,1	51,4	122,7		

<sup>1)</sup> Für weitere Informationen ist die ETA-Bewertung zu beachten.

<sup>2)</sup> Lastangaben berücksichtigen die in der Bewertung angegebenen Teilsicherheitsbeiwerte der Widerstände sowie einen Teilsicherheitsbeiwert der Einwirkungen von  $\gamma_F = 1,4$ .

Bei den angegebenen Werten wird von einem Abstand der Bewehrungsstäbe  $S \geq 15$  cm bzw. eines Abstandes der Bewehrungsstäbe  $S \geq 10$  cm bei einem Durchmesser  $d_s \leq 10$  mm ausgegangen.

<sup>3)</sup> Bei höheren Betonfestigkeiten bis C50/60 erhöhen sich die Zuglastwerte um bis zu 58%.

# Blitz-anker BAZ



## Vorteile



BAZ, galv. verz.



BAZ A4, nichtrostender Stahl A4



BAZ HD, feuerverzinkt



BAZ HCR, nichtrostender Stahl, hochkorrosionsbeständig

## Geeignete Baustoffe

### Sehr gut geeignet



- Beton gerissen
- Beton ungerissen



### Bedingt geeignet

- Dichter Naturstein (bis M8)

## Zulassungen und Zertifikate



Europäische Technische Bewertung  
Option 1 für gerissenen Beton

siehe Bewertung

M8 - M16

## Montage

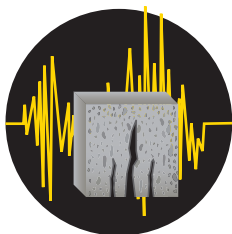
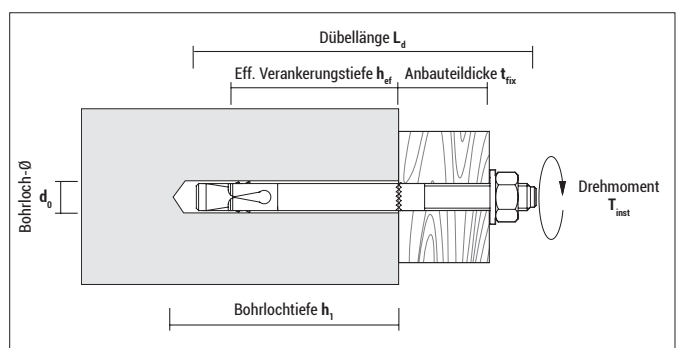
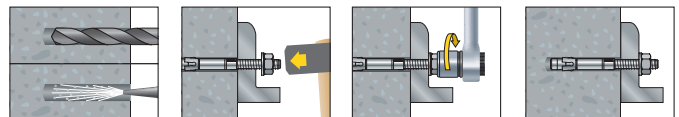

**Sehr gute Leistungswerte**  
in gerissenen Beton  
und unter seismischen  
Einwirkungen [C1]



**Hohe Lastwerte**  
bei geringen Rand- und  
Achsabständen



**Großes Sortiment**  
in verschiedenen  
Materialien



**Als Blister oder  
Einzelpreis** für Ihre  
individuellen Projekte

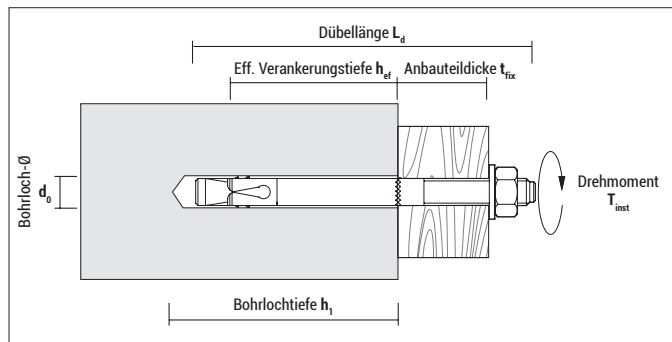

**BAZ, galv. verz.**

Typ	Art.-Nr.	d <sub>0</sub> [mm]	h <sub>1</sub> ≥ [mm]	h <sub>ef</sub> ≥ [mm]	L <sub>d</sub> [mm]	t <sub>fix</sub> ≤ [mm]	Gewinde		[Stück]	[Stück]
6-40/2	9640BAZ	6	35	25	40	2	M6	–	150	750
6-65/15	9665BAZ	6	45	35	65	15	M6	–	100	500
8-52/2	9852BAZ	8	45	30	52	2	M8	–	100	500
8-72/10	9872BAZ	8	60	45	72	10	M8	●	50	250
8-92/30	9892BAZ	8	60	45	92	30	M8	●	50	250
8-112/50	98112BAZ	8	60	45	112	50	M8	●	40	200
8-147/85	98147BAZ	8	60	45	147	85	M8	●	40	200
10-92/10	91092BAZ	10	75	60	92	10	M10	●	40	200
10-102/20	910102BAZ	10	75	60	102	20	M10	●	25	125
10-112/30	910112BAZ	10	75	60	112	30	M10	●	25	125
10-132/50	910132BAZ	10	75	60	132	50	M10	●	25	125
10-162/80	910162BAZ	10	75	60	162	80	M10	●	25	125
12-103/5	912103BAZ	12	90	70	103	5	M12	●	20	100
12-118/20	912118BAZ	12	90	70	118	20	M12	●	20	100
12-128/30	912128BAZ	12	90	70	128	30	M12	●	20	100
12-148/50	912148BAZ	12	90	70	148	50	M12	●	20	100
12-163/65	912163BAZ	12	90	70	163	65	M12	●	20	100
12-178/80	912178BAZ	12	90	70	178	80	M12	●	20	100
16-123/5	916123BAZ	16	110	85	123	5	M16	●	10	50
16-138/20	916138BAZ	16	110	85	138	20	M16	●	10	50
16-178/60	916178BAZ	16	110	85	178	60	M16	●	10	50



**BAZ A4, nichtrostender Stahl A4**





Typ	Art.-Nr.	d <sub>0</sub> [mm]	h <sub>1</sub> ≥ [mm]	h <sub>ef</sub> ≥ [mm]	L <sub>d</sub> [mm]	t <sub>fix</sub> ≤ [mm]	Gewinde		[Stück]	[Stück]
6-40/2 A4	9X640BAZ	6	35	25	40	2	M6	–	150	750
6-65/15 A4	9X665BAZ	6	45	35	65	15	M6	–	100	500
8-52/2 A4	9X852BAZ	8	45	30	52	2	M8	–	100	500
8-72/10 A4	9X872BAZ	8	60	45	72	10	M8	●	50	250
8-92/30 A4	9X892BAZ	8	60	45	92	30	M8	●	50	250
8-112/50 A4	9X8112BAZ	8	60	45	112	50	M8	●	40	200
10-60/10 A4	9X1060BAZ	10	38	23	60	10	M10	–	50	250
10-92/10 A4	9X1092BAZ	10	75	60	92	10	M10	●	40	200
10-102/20 A4	9X10102BAZ	10	75	60	102	20	M10	●	25	125
10-112/30 A4	9X10112BAZ	10	75	60	112	30	M10	●	25	125
10-132/50 A4	9X10132BAZ	10	75	60	132	50	M10	●	25	125
12-103/5 A4	9X12103BAZ	12	90	70	103	5	M12	●	20	100
12-118/20 A4	9X12118BAZ	12	90	70	118	20	M12	●	20	100
12-128/30 A4	9X12128BAZ	12	90	70	128	30	M12	●	20	100
12-148/50 A4	9X12148BAZ	12	90	70	148	50	M12	●	20	100
12-163/65 A4	9X12163BAZ	12	90	70	163	65	M12	●	20	100
16-123/5 A4	9X16123BAZ	16	110	85	123	5	M16	●	10	50
16-138/20 A4	9X16138BAZ	16	110	85	138	20	M16	●	10	50
16-168/50 A4	9X16168BAZ	16	110	85	168	50	M16	●	10	50







## Blister BAZ, galv. verz.

Typ	Art.-Nr.	d <sub>0</sub> [mm]	h <sub>1</sub> ≥ [mm]	h <sub>ef</sub> ≥ [mm]	L <sub>d</sub> [mm]	t <sub>fix</sub> ≤ [mm]	Gewinde		 [Stück]	 [Blister]
8-72/10	5874BAZ2	8	60	45	72	10	M8	●	2	10
10-92/10	51095BAZ2	10	75	60	92	10	M10	●	2	10
12-118/20	512115BAZ2	12	90	70	118	20	M12	●	2	10





## BAZ HD, feuerverzinkt

Typ	Art.-Nr.	d <sub>0</sub> [mm]	h <sub>1</sub> ≥ [mm]	h <sub>ef</sub> ≥ [mm]	L <sub>d</sub> [mm]	t <sub>fix</sub> ≤ [mm]	Gewinde		 [Stück]	 [Stück]
6-40/2 HD	9HD640BAZ	6	35	25	40	2	M6	–	150	750
6-65/15 HD	9HD665BAZ	6	45	35	65	15	M6	–	100	500
8-52/2 HD	9HD852BAZ	8	45	30	52	2	M8	–	100	500
8-72/10 HD	9HD872BAZ	8	60	45	72	10	M8	●	50	250
8-92/30 HD	9HD892BAZ	8	60	45	92	30	M8	●	50	250
8-112/50 HD	9HD8112BAZ	8	60	45	112	50	M8	●	40	200
8-147/85 HD	9HD8147BAZ	8	60	45	147	85	M8	●	40	200
10-60/10 HD	9HD1060BAZ	10	38	23	60	10	M10	–	50	250
10-92/10 HD	9HD1092BAZ	10	75	60	92	10	M10	●	40	200
10-102/20 HD	9HD10102BAZ	10	75	60	102	20	M10	●	25	125
10-112/30 HD	9HD10112BAZ	10	75	60	112	30	M10	●	25	125
10-132/50 HD	9HD10132BAZ	10	75	60	132	50	M10	●	25	125
10-162/80 HD	9HD10162BAZ	10	75	60	162	80	M10	●	25	125
12-103/5 HD	9HD12103BAZ	12	90	70	103	5	M12	●	20	100
12-118/20 HD	9HD12118BAZ	12	90	70	118	20	M12	●	20	100
12-128/30 HD	9HD12128BAZ	12	90	70	128	30	M12	●	20	100
12-148/50 HD	9HD12148BAZ	12	90	70	148	50	M12	●	20	100
12-163/65 HD	9HD12163BAZ	12	90	70	163	65	M12	●	20	100
12-178/80 HD	9HD12178BAZ	12	90	70	178	80	M12	●	20	100
16-123/5 HD	9HD16123BAZ	16	110	85	123	5	M16	●	10	50
16-138/20 HD	9HD16138BAZ	16	110	85	138	20	M16	●	10	50
16-168/50 HD	9HD16168BAZ	16	110	85	168	50	M16	●	10	50
16-178/60 HD	9HD16178BAZ	16	110	85	178	60	M16	●	10	50





## BAZ HCR, nichtrostender Stahl, hochkorrosionsbeständig

Typ	Art.-Nr.	d <sub>0</sub> [mm]	h <sub>1</sub> ≥ [mm]	h <sub>ef</sub> ≥ [mm]	L <sub>d</sub> [mm]	t <sub>fix</sub> ≤ [mm]	Gewinde		 [Stück]	 [Stück]
8-72/10 HCR	9HCR872BAZ	8	60	45	72	10	M8	●	50	250
10-92/10 HCR	9HCR1092BAZ	10	75	60	92	10	M10	●	40	200
10-112/30 HCR	9HCR10112BAZ	10	75	60	112	30	M10	●	25	125

Keine Lagerware; nur auf Anfrage



## Einzelverkauf BAZ, galv. verz.

Typ	Art.-Nr.	d <sub>0</sub> [mm]	h <sub>1</sub> ≥ [mm]	h <sub>ef</sub> ≥ [mm]	L <sub>d</sub> [mm]	t <sub>fix</sub> ≤ [mm]	Gewinde		 [Stück]
8-72/10	1872BAZ	8	60	45	72	10	M8	●	50
8-92/30	1892BAZ	8	60	45	92	30	M8	●	50
10-92/10	11092BAZ	10	75	60	92	10	M10	●	40
10-112/30	110112BAZ	10	75	60	112	30	M10	●	25
12-118/20	112118BAZ	12	90	70	118	20	M12	●	20
12-148/50	112148BAZ	12	90	70	148	50	M12	●	20



### Einzelverkauf BAZ A4, nichtrostender Stahl A4

Typ	Art.-Nr.	d <sub>0</sub> [mm]	h <sub>1</sub> ≥ [mm]	h <sub>ef</sub> ≥ [mm]	L <sub>d</sub> [mm]	t <sub>fix</sub> ≤ [mm]	Gewinde	ETA	[Stück]
8-72/10 A4	1X872BAZ	8	60	45	72	10	M8	●	50
8-92/30 A4	1X892BAZ	8	60	45	92	30	M8	●	50
10-92/10 A4	1X1092BAZ	10	75	60	92	10	M10	●	40
10-112/30 A4	1X10112BAZ	10	75	60	112	30	M10	●	25
12-118/20 A4	1X12118BAZ	12	90	70	118	20	M12	●	20

### Montagedaten

BAZ Größe	BAZ Typ	T <sub>inst</sub> [Nm]	M8		M10	M12		M16	
			BAZ BAZ HD	BAZ A4 BAZ HCR		BAZ BAZ HD	BAZ A4 BAZ HCR		
Drehmoment		T <sub>inst</sub> [Nm]	7	20 / 15**	20	35	50	70	120
Schlüsselweite		SW [mm]	10		13	17	19		24
Durchgangsloch im anzuschließenden Anbauteil		d <sub>f</sub> [mm]	7		9	12	14		18
Unterlegscheibe Außen-Ø x Dicke		[mm]	12 x 1,6		17 x 1,6	21 x 2,0	24 x 2,5		30 x 3,0

\* Nicht Bestandteil der Zulassung

\*\* 20 für BAZ, 15 für BAZ HD

### Achs- und Randabstände

BAZ Größe		M8	M10	M12	M16
Effektive Verankerungstiefe	h <sub>ef</sub> [mm]	45	60	70	85
Minimaler Randabstand	C <sub>min</sub> [mm]	50	50	55	85
	für S ≥ [mm]	50	100	145	150
Minimaler Achsabstand	S <sub>min</sub> [mm]	50	55	60	70
	für C ≥ [mm]	50	80	90	120
Charakteristischer Randabstand	C <sub>cr</sub> [mm]	68	90	105	128
Charakteristischer Achsabstand	S <sub>cr</sub> [mm]	135	180	210	255
Mindestbauteildicke	h <sub>min</sub> [mm]	100	120	140	170

Bei Unterschreitung des char. Rand-/Achsabstandes (C<sub>cr</sub> bzw. S<sub>cr</sub>) muss die Tragfähigkeit abgemindert werden. h<sub>min</sub>, S<sub>min</sub> und C<sub>min</sub> dürfen nicht unterschritten werden.

### Tragfähigkeiten

BAZ Größe	BAZ Typ	M8		M10		M12		M16	
		BAZ verz. BAZ HD	BAZ A4 BAZ HCR	BAZ verz. BAZ HD	BAZ A4 BAZ HCR	BAZ verz. BAZ HD	BAZ A4 BAZ HCR	BAZ verz. BAZ HD	BAZ A4 BAZ HCR
<b>Zulässige zentrische Zuglast eines Einzeldübel ohne Randeinfluss<sup>1), 2)</sup></b>									
Im gerissenen Beton C20/25 <sup>3)</sup>	N <sub>zul</sub> [kN]	5,0	5,0	3,6	3,6	4,8	4,8	9,5	25,7
Im ungerissenen Beton C20/25 <sup>3)</sup>	N <sub>zul</sub> [kN]	3,6	3,6	6,3	6,3	7,9	7,9	16,7	16,7
<b>Zulässige Querkraft eines Einzeldübel ohne Randeinfluss<sup>1), 2)</sup></b>									
Im gerissenen Beton C20/25	V <sub>zul</sub> [kN]	5,2	5,2	10,3	9,7	13,1	14,3	25,1	26,9
Im ungerissenen Beton C20/25	V <sub>zul</sub> [kN]	5,7	6,3	10,3	9,7	13,1	14,3	25,1	26,9
Zulässiges Biegemoment	M <sub>zul</sub> [Nm]	12,0	12,6	27,4	25,7	41,1	45,1	106,3	114,3

<sup>1)</sup> Für weitere Informationen ist die ETA-Bewertung zu beachten.

<sup>2)</sup> Lastangaben berücksichtigen die in der Bewertung angegebenen Teilsicherheitsbeiwerte der Widerstände sowie einen Teilsicherheitsbeiwert der Einwirkungen von γ<sub>F</sub> = 1,4. Bei den angegebenen Werten wird von einem Abstand der Bewehrungsstäbe S ≥ 15 cm bzw. eines Abstandes der Bewehrungsstäbe S ≥ 10 cm bei einem Durchmesser d<sub>s</sub> ≤ 10 mm ausgegangen.

<sup>3)</sup> Bei höheren Betonfestigkeiten bis C50/60 erhöhen sich die Zuglastwerte um bis zu 28%.

### Empfohlene Lasten für die nicht zugelassenen Dübelgrößen M6, M10 in ungerissenen Beton C20/25

Typ	N <sub>empf</sub> [kN]	V <sub>empf</sub> [kN]	Setztiefe h <sub>cr</sub> [mm]
BAZ 6-40/2	1,6	2,0	25
BAZ 6-65/15	1,8	2,5	35
BAZ 8-52/2	2,6	4,8	30
BAZ 10-60/10	1,6	2,0	23

N<sub>empf</sub>: empfohlene Zuglast; V<sub>empf</sub>: empfohlene Querkraft

# Blitz-anker BA plus



## Vorteile



BA plus, galv. verz.

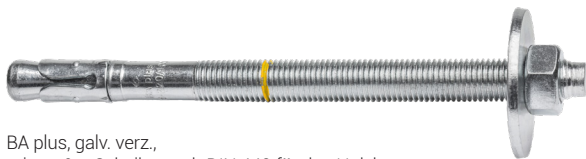

BA plus, galv. verz.,  
mit großer Scheibe nach DIN 440 für den Holzbau

## Geeignete Baustoffe

### Sehr gut geeignet



- Beton ungerissen



### Bedingt geeignet

- Dichter Naturstein (bis M8)

## Zulassungen und Zertifikate



Europäisch Technische Bewertung  
Option 7 für ungerissenen Beton

## Montage

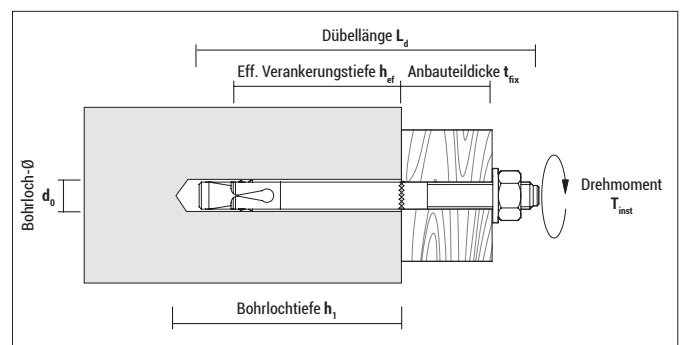
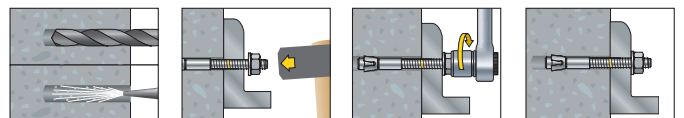

**Exzellente Haltewerte**  
im ungerissenen Beton

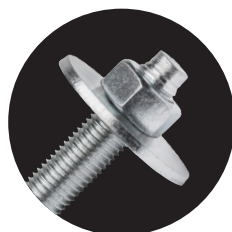

Großes **Sortiment für den Holzbau** mit großer Scheibe nach DIN 440 verfügbar



**Setztiefenmarkierung**  
als Montagehilfe

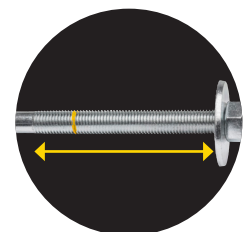

**Langes Gewinde**  
für hohe Montageflexibilität

**CELO**



**BA plus, galv. verz.**

Typ	Art.-Nr.	d <sub>0</sub> [mm]	h <sub>1</sub> ≥ [mm]	h <sub>er</sub> ≥ [mm]	L <sub>d</sub> [mm]	t <sub>fix</sub> ≤ [mm]	Gewinde		[Stück]	[Stück]
6-45/5	9645BAP	6	38	25	45	5	M6	—	100	500
6-60/10	9660BAP	6	48	35	60	10	M6	●	100	500
6-80/30	9680BAP	6	48	35	80	30	M6	●	100	500
6-100/50	96100BAP	6	48	35	100	50	M6	●	100	500
8-50/5	9850BAP	8	40	25	50	5	M8	—	100	500
8-75/10	9875BAP	8	60	45	75	10	M8	●	50	250
8-85/20	9885BAP	8	60	45	85	20	M8	●	50	250
8-95/30	9895BAP	8	60	45	95	30	M8	●	50	250
8-115/50	98115BAP	8	60	45	115	50	M8	●	40	200
8-135/70	98135BAP	8	60	45	135	70	M8	●	40	200
10-60/10	91060BAP	10	42	27	60	10	M10	—	50	250
10-75/10	91075BAP	10	55	40	75	10	M10	—	50	250
10-85/10	91085BAP	10	65	50	85	10	M10	●	40	200
10-92/17	91092BAP	10	65	50	92	17	M10	●	40	200
10-105/30	910105BAP	10	65	50	105	30	M10	●	25	125
10-125/50	910125BAP	10	65	50	125	50	M10	●	25	125
10-145/70	910145BAP	10	65	50	145	70	M10	●	25	125
10-175/100	910175BAP	10	65	50	175	100	M10	●	25	125
12-70/2	91270BAP	12	58	38	70	2	M12	—	40	200
12-110/10	912110BAP	12	90	70	110	10	M12	●	20	100
12-120/20	912120BAP	12	90	70	120	20	M12	●	20	100
12-130/30	912130BAP	12	90	70	130	30	M12	●	20	100
12-150/50	912150BAP	12	90	70	150	50	M12	●	20	100
12-180/80	912180BAP	12	90	70	180	80	M12	●	20	100
16-95/10	91695BAP	16	75	50	95	10	M16	—	15	75
16-135/15	916135BAP	16	110	85	135	15	M16	●	10	50
16-150/30	916150BAP	16	110	85	150	30	M16	●	10	50
16-180/60	916180BAP	16	110	85	180	60	M16	●	10	50
16-200/80	916200BAP	16	110	85	200	80	M16	●	10	50
20-110/10	920110BAP	20	90	60	110	10	M20	—	10	40
20-160/20	920160BAP	20	130	100	160	20	M20	●	10	40
20-215/75	920215BAP	20	130	100	215	75	M20	●	6	24
20-270/130	920270BAP	20	130	100	270	130	M20	●	5	20

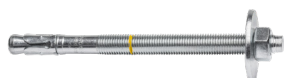

**BA plus, galv. verz.** mit großer Scheibe nach ISO 7094 (DIN 440) für den Holzbau

Typ	Art.-Nr.	d <sub>0</sub> [mm]	h <sub>1</sub> ≥ [mm]	h <sub>er</sub> ≥ [mm]	L <sub>d</sub> [mm]	t <sub>fix</sub> ≤ [mm]	Gewinde		[Stück]	[Stück]
10-215/140	910215BAP	10	65	50	215	140	M10	●	25	100
12-200/100	912200BAP	12	90	70	200	100	M12	●	20	80
12-220/120	912220BAP	12	90	70	220	120	M12	●	20	80
12-240/140	912240BAP	12	90	70	240	140	M12	●	20	80
12-260/160	912260BAP	12	90	70	260	160	M12	●	20	80
12-300/200	912300BAP	12	90	70	300	200	M12	●	15	60
12-320/220	912320BAP	12	90	70	320	220	M12	●	15	60
16-220/100	916220BAP	16	110	85	220	100	M16	●	10	40
16-270/150	916270BAP	16	110	85	270	150	M16	●	10	40
16-320/200	916320BAP	16	110	85	320	200	M16	●	10	40



**Blister BA plus, galv. verz.**



Typ	Art.-Nr.	d <sub>0</sub> [mm]	h <sub>1</sub> ≥ [mm]	h <sub>er</sub> ≥ [mm]	L <sub>d</sub> [mm]	t <sub>fix</sub> ≤ [mm]	Gewinde		[Stück]	[Blister]
8-85/20	5885BA2	8	60	45	85	20	M8	●	2	10
10-92/17	51090BA2	10	65	50	92	17	M10	●	2	10
10-125/50	510120BA2	10	65	50	125	50	M10	●	2	10



**Einzelverkauf BA plus, galv. verz.**

Typ	Art.-Nr.	d <sub>0</sub> [mm]	h <sub>1</sub> ≥ [mm]	h <sub>ef</sub> ≥ [mm]	L <sub>d</sub> [mm]	t <sub>fix</sub> ≤ [mm]	Gewinde		[Stück]
8-75/10	1875BAP	8	60	45	75	10	M8	●	50
10-92/17	11092BAP	10	65	50	92	17	M10	●	40
10-125/50	110125BAP	10	65	50	125	50	M10	●	25
12-110/10	112110BAP	12	90	70	110	10	M12	●	20
12-150/50	112150BAP	12	90	70	150	50	M12	●	20
12-180/80	112180BAP	12	90	70	180	80	M12	●	20



**Einzelverkauf BA plus, galv. verz.** mit großer Scheibe nach DIN 440 für den Holzbau

Typ	Art.-Nr.	d <sub>0</sub> [mm]	h <sub>1</sub> ≥ [mm]	h <sub>ef</sub> ≥ [mm]	L <sub>d</sub> [mm]	t <sub>fix</sub> ≤ [mm]	Gewinde		[Stück]
12-200/100	112200BAP	12	90	70	200	100	M12	●	10
12-240/140	112240BAP	12	90	70	240	140	M12	●	10

**Montagedaten**

BA plus Größe		M6	M8	M10	M12	M16	M20
Drehmoment	T <sub>inst</sub> [Nm]	8	15	30	50	110	180
Schlüsselweite	SW [mm]	10	13	17	19	24	30
Durchgangsloch anzuschließendens Anbauteil	d <sub>f</sub> [mm]	7	9	12	14	18	22
Unterlegscheibe Außen-Ø x Dicke	[mm]	12 x 1,6	16 x 1,6	20 x 2 / 34 x 3	24 x 2,5 / 44 x 4	30 x 3 / 56 x 5	37 x 3

**Tragfähigkeiten, Achs- und Randabstände BA plus zugelassene Größen M6 - M20**

Typ	Zulässige Tragfähigkeiten in ungerissemem Beton <sup>1(2),3)</sup>		Zulässiges Biegemoment M <sub>zul</sub> [Nm]	Achsabstand <sup>4)</sup>		Randabstand <sup>4)</sup>		Min. Bauteildicke h <sub>min</sub> [mm]
	Zug N <sub>zul</sub> [kN]	Quer V <sub>zul</sub> [kN]		S <sub>cr</sub> [mm]	S <sub>min</sub> [mm]	C <sub>cr</sub> [mm]	C <sub>min</sub> [mm]	
BA plus 6	3,6	3,0	4,7	105	50	53	50	100
BA plus 8	7,3	6,5	13,4	135	50	68	50	100
BA plus 10	7,6	8,5	23,9	150	120	75	90	120
BA plus 12	11,4	9,5	46,8	210	70	105	90	160
BA plus 16	12,7	14,6	95,1	255	100	128	100	200
BA plus 20	19,8	24,0	127,3	300	160	150	150	200

<sup>1)</sup> Zulässige Lasten eines Einzeldübels ohne Randeinflüsse.

<sup>2)</sup> Lastangaben berücksichtigen die in der Bewertung angegebenen Teilsicherheitsbeiwerte des Materials sowie einen Teilsicherheitsbeiwert der Einwirkungen von γ<sub>F</sub> = 1,4.

<sup>3)</sup> Bei höheren Betonfestigkeiten bis C50/60 erhöhen sich die Zuglastwerte um bis zu 55%.

<sup>4)</sup> Bei Unterschreitung des char. Rand-/Achsabstandes (C<sub>cr</sub> bzw. S<sub>cr</sub>) muss die Tragfähigkeit abgemindert werden. h<sub>min</sub>, S<sub>min</sub> und C<sub>min</sub> dürfen nicht unterschritten werden.

**Empfohlene Lasten für die nicht zugelassenen Dübelgrößen in ungerissemem Beton C20/25**

Typ	N <sub>empf</sub> [kN]	V <sub>empf</sub> [kN]	Setztiefe h <sub>ef</sub> [mm]
BA plus 6-45/5	1,5	1,5	25
BA plus 8-50/5	1,5	1,5	25
BA plus 10-60/10	1,8	1,8	27
BA plus 10-75/10	2,5	2,5	40
BA plus 12-70/2	2,4	2,4	38
BA plus 16-95/10	4,0	4,0	50
BA plus 20-110/10	6,0	6,0	60

N<sub>empf</sub>: empfohlene Zuglast; V<sub>empf</sub>: empfohlene Querlast

# Blitz-anker BA A4



## Vorteile



BA A4, nichtrostender Stahl A4

## Geeignete Baustoffe

### Sehr gut geeignet



- Beton ungerissen



### Bedingt geeignet

- Dichter Naturstein (bis M8)

## Zulassungen und Zertifikate



Europäisch Technische Bewertung  
Option 7 für ungerissenen Beton

## Montage

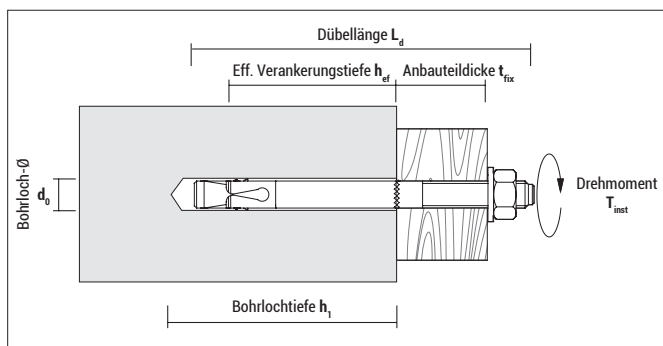
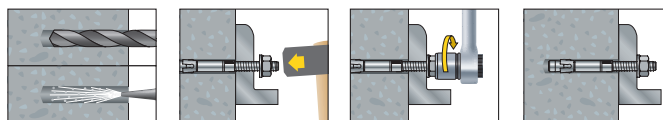

**Blitzanker aus nicht-rostendem Stahl A4**  
für die Schnellmontage in ungerissenen Beton





**Geeignet für vielfältige zulassungsrelevante Anwendungen;**  
insbesondere für Außenanwendungen, Fassadenunterkonstruktionen uvm.



**Hohe Lastwerte bei geringen Rand- und Achsabständen**  
einsetzbar auch bei schwierigen Einbausituationen



## BA A4, nichtrostender Stahl A4

Typ	Art.-Nr.	$d_0$ [mm]	$h_1 \geq$ [mm]	$h_{ef} \geq$ [mm]	$L_d$ [mm]	$t_{fix} \leq$ [mm]	Gewinde		 [Stück]	 [Stück]
8-72/10 A4	9X872BA	8	60	45	72	10	M8	●	50	250
8-92/30 A4	9X892BA	8	60	45	92	30	M8	●	50	250
8-112/50 A4	9X8112BA	8	60	45	112	50	M8	●	40	200
10-92/10 A4	9X1092BA	10	75	60	92	10	M10	●	40	200
10-102/20 A4	9X10102BA	10	75	60	102	20	M10	●	25	125
10-112/30 A4	9X10112BA	10	75	60	112	30	M10	●	25	125
10-132/50 A4	9X10132BA	10	75	60	132	50	M10	●	25	125
12-103/5 A4	9X12103BA	12	90	70	103	5	M12	●	20	100
12-118/20 A4	9X12118BA	12	90	70	118	20	M12	●	20	100
12-128/30 A4	9X12128BA	12	90	70	128	30	M12	●	20	100
12-148/50 A4	9X12148BA	12	90	70	148	50	M12	●	20	100
12-163/65 A4	9X12163BA	12	90	70	163	65	M12	●	20	100
16-123/5 A4	9X16123BA	16	110	85	123	5	M16	●	10	50
16-138/20 A4	9X16138BA	16	110	85	138	20	M16	●	10	50
16-168/50 A4	9X16168BA	16	110	85	168	50	M16	●	10	50

## Montagedaten

BA Größe	M8	M10	M12	M16	
Drehmoment	$T_{inst}$ [Nm]	20	35	70	120
Schlüsselweite	SW [mm]	13	17	19	24
Durchgangsloch im anzuschließenden Anbauteil	$d_f$ [mm]	9	12	14	18
Unterlegscheibe Außen- $\varnothing$ x Dicke	[mm]	17 x 1,6	21 x 2,0	24 x 2,5	30 x 3,0

## Tragfähigkeiten, Achs- und Randabstände BA A4 zugelassene Größen M8 - M16

Typ	Zulässige Tragfähigkeiten in ungerissenem Beton <sup>1)2)3)</sup>		Zulässiges Biegemoment $M_{zul}$ [Nm]	Achsabstand <sup>4)</sup>		Randabstand <sup>4)</sup>		Min. Bauteildicke $h_{min}$ [mm]
	C 20/25 Zug $N_{zul}$ [kN]	C 20/25 Quer $V_{zul}$ [kN]		$S_{min}$ [mm]	$S_{cr}$ [mm]	$C_{min}$ [mm]	$C_{cr}$ [mm]	
BA A4 8	3,6	6,3	12,6	50	135	50	68	100
BA A4 10	6,3	9,7	25,7	55	180	50	90	120
BA A4 12	7,9	14,3	45,1	60	210	55	105	140
BA A4 16	16,7	26,9	114,3	70	255	85	128	170

<sup>1)</sup> Zulässige Lasten eines Einzeldübels ohne Randeinflüsse.

<sup>2)</sup> Lastangaben berücksichtigen die in der Bewertung angegebenen Teilsicherheitsbeiwerte des Materials sowie einen Teilsicherheitsbeiwert der Einwirkungen von  $\gamma_F = 1,4$ .

<sup>3)</sup> Bei höheren Betonfestigkeiten bis C50/60 erhöhen sich die Zuglastwerte um bis zu 28%.

<sup>4)</sup> Bei Unterschreitung des char. Rand-/Achsabstandes ( $C_{cr}$  bzw.  $S_{cr}$ ) muss die Tragfähigkeit abgemindert werden.  $h_{min}$ ,  $S_{min}$  und  $C_{min}$  dürfen nicht unterschritten werden.



CELO Befestigungssysteme GmbH  
Industriestraße 6  
D-86551 Aichach  
[www.celofixings.com](http://www.celofixings.com)  
Hotline: +49 (0) 8251-90485-0  
Telefax: +49 (0) 8251-90485-49  
E-mail: [info@celofixings.de](mailto:info@celofixings.de)

## Small Things Matter

Überreicht durch:

DE 01/21

Technische Änderungen in den Produkten und Abbildungen vorbehalten. Der Nachdruck dieses Prospektes, auch auszugsweise, ist untersagt.  
CELO Befestigungssysteme GmbH übernimmt keinerlei Haftung für die Richtigkeit der bereitgestellten Information.